

E9

EN

Connected and intuitive, tailor-made sterilization



Euronda[®]
Pro System

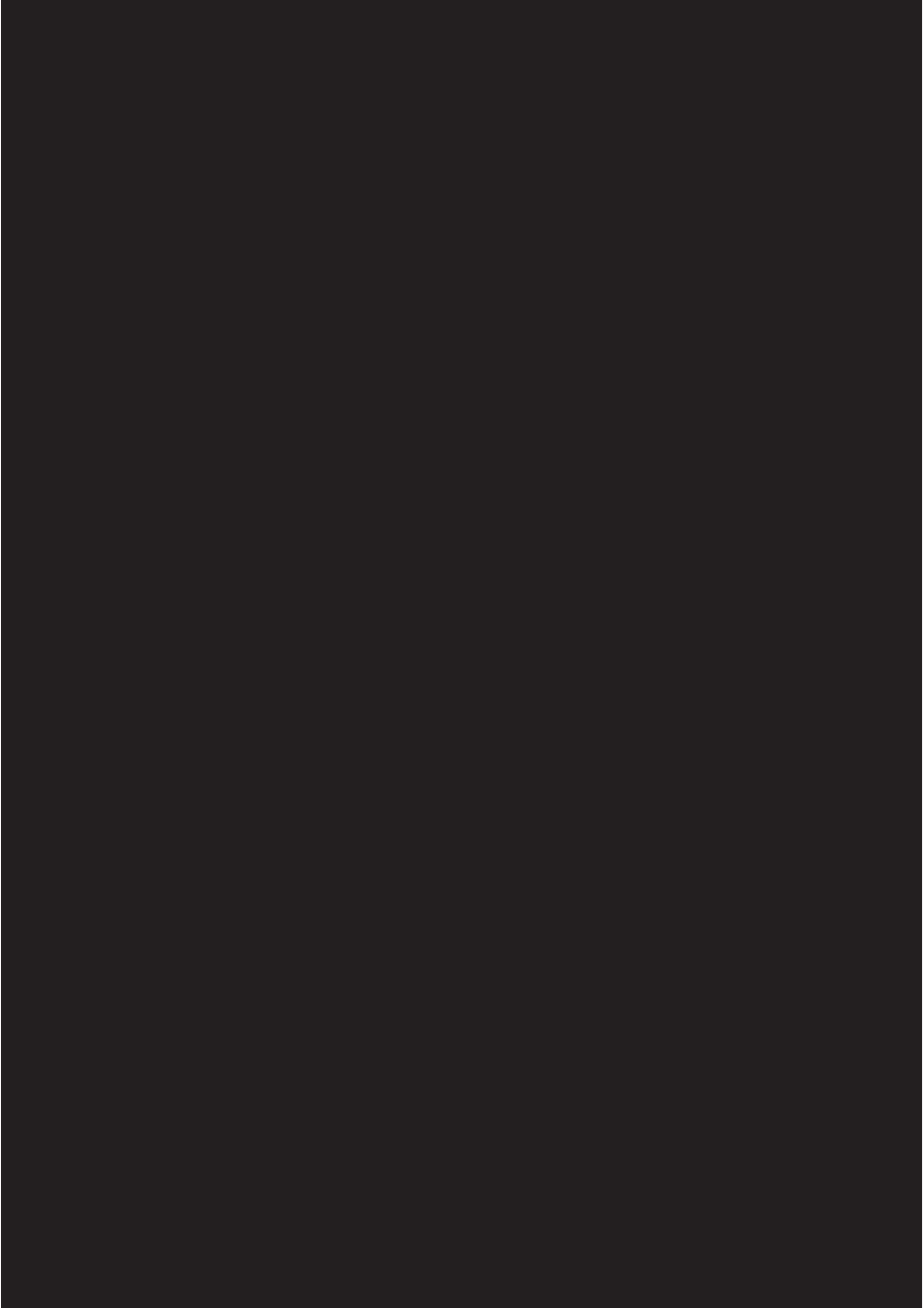

E9

Connected and intuitive, tailor-made sterilization

6 E9

8 Euronda Pro System technologies and solutions

10 Sterilization cycles and testing programs

B Cycles
S and N Cycles

14 Load capacity Optional accessories

16 Complete and expandable traceability E-Memory

19 Control test

20 Water treatment systems Aquaosmo Aquafilter 1 to 1 Aquadist

24 Technical features

25 Technical data sheet

Euronda Pro System

Products, Process, Protection



Cleaning



**Thermo-
disinfection**

Eurosafe 170
Eurosafe 60



**Ultrasonic
washing**

Eurosonic 4D
Eurosonic 3D
Eurosonic Energy

Packaging



**Thermo-
sealing**

Euromatic
Euroseal Valida
Euroseal
Euroseal Infinity



**Sterilization rolls
and pouches**

Euronda Pro System is the protection system developed to guarantee a complete and effective instrument reprocessing protocol that protects the safety of operators, patients and the working environment.

Sterilization is a multi-step process and its success depends on the correct execution of each step, from collection to storage. Thanks to the Euronda Pro System line, an advanced and traceable protocol that increases safety and optimises the practice's resources can be applied simply, efficiently and repeatedly over time.



Sterilization



Autoclaves

E10
EXL
E9
E8



Water treatment systems

Aquaosmo
Aquafilter 1 to 1
Aquadist



Intuitive

E9 is developed to make everyday tasks easier and faster. Its 4.3" touch screen display, with clear and essential icons, simplifies navigation for immediate and complete control.



Connected

The integrated SD Card and the standard Ethernet or WiFi connection ensure the data on sterilization cycles are always available. The E-Memory software, available free of charge, enables the archiving of all data on a PC.



Functional

Designed down to the last detail for optimal and long-lasting operation, E9 utilises optimised procedures and consumption with a focus on making maintenance tasks easier and faster.



Advantageous

Reliability and performance without compromise: cycle after cycle, E9 delivers flawless sterilization and drying results, bringing all the quality of the best Euronda Pro Systems to your clinic.



E9

Connected and intuitive, tailor-made sterilization

Immediate, efficient and reliable: E9 enables the complete and connected management of sterilization data with the best digital and paper-based traceability systems. Its intuitive interface, with a 4.3" colour display, simplifies and speeds up daily operations. E9 offers the option of selecting 5 different B cycles and, after entering a password, 2 S and N cycles. In addition to cycles, tests can also be programmed to optimise the use of time. Thanks to the SD card and Ethernet connection (both standard), all cycle data can be transferred and conveniently managed on a PC via the free E-Data software, while the optional WiFi enables full digital traceability. It is also possible to install 3 different types of optional printers, at any time, for printing receipts or thermal labels containing data or barcodes. The control systems and advanced functionalities common to all Euronda Pro System autoclaves guarantee safe processes and results over time: the Inspection System allows easy and frequent cleaning; the Dirt Control System separates clean and dirty water flows, draining the dirt from the hydraulic circuit; the conductivity meter constantly monitors water quality; while the air-water separator optimises the pump operation.



Classification

Medical Device Class IIb



Dimensions

46 x 43.5 x 61 cm (wxhxd)



Peso

47.5 Kg (empty machine with basket and trays)



Chamber capacity

24 L



Power supply

230 V | 50/60 Hz

Power consumption

2300 W



Water consumption

0.3 L



Connectivity

Included: Ethernet, SD card, E-Memory and E-Data software
Optional: WiFi



CE Ref

SSU\M24L2023

Euronda Pro System technologies and solutions

Efficiency and reliability in a single platform

Euronda Pro System autoclaves are developed on a common platform that guarantees efficiency, reliability, safety and usability on every model in the range.

All autoclaves share the same modular structure, optimised control and management systems, accessories and spare parts.





Modular system

The modular design of the Euronda Pro System autoclaves allows the side panels to be easily removed for ease of maintenance.



Inspection System

The world's first inspection system for autoclaves in full compliance with EN 13060. Inspection System makes tank cleaning quick and easy.



Conductivity meter

The integrated conductivity sensor constantly monitors the water quality, preventing possible malfunctions due to the use of unsuitable water.



Steam generator

The instant steam generator guarantees excellent performance in terms of speed, safety and sterilization. It improves water consumption by calibrating it according to the load and, in synergy with the heating elements, offers perfect drying.



Air-water separator

The air-water separator is a "lifesaver" for the vacuum pump: it separates flows containing steam, air, dirt, lubricating oils and residues from the instruments to be sterilized from the air, creating ideal operating conditions for the pump and preserving its efficiency.



Dirt Control System

The dirt management system in the hydraulic circuit allows precise separation of clean and dirty water flows so that the autoclave can continue to work at maximum efficiency.



Smart cooling system

The cooling system is equipped with a probe that allows the most efficient management of the vacuum pump, ensuring longer life and effectiveness.





Sterilization cycles and test programs

E9 offers the possibility of performing B, N and S cycles in addition to test programs (Vacuum, Helix, Bowie and Dick). From the menu it is possible to select 3 type B cycles (121°, 134°, 134° Prion) and 2 fast cycles (134° fast, 134° Prion fast), in full compliance with EN 13060.

Fast cycles allow sterilization of a small load (1 tray and a 0.6 kg solid load) 30% faster than standard cycles.

It is also possible to perform N (N134, N121) and S (S134, S121) type cycles, which can be activated by a password.

Cycle programming

E9 allows you to programme the start of the sterilization cycles and tests at the desired time, optimising the workload of the clinic. With this function, the vacuum test can be scheduled before the practice opens, with the flexibility to start an additional test or sterilization cycle if necessary.

Test Reminder

E9 allows a reminder to be set for running test programs at a desired time interval, making it easier to manage the clinic and operate safely at all times.

B Cycles

	B 134	B 121	
Description	Cycle for bagged and non-bagged solid, porous or hollow material	Cycle for solid or porous, bagged and non-bagged material, particularly suitable for sterilization of plastics, turbines and handpieces	
Temperature	134°C	121°C	
Pressure	2,05 bar	1.05 bar	
Sterilization phase duration	4'	20'	
Drying phase duration	15'	15'	
Total duration with standard load*	29'	44'	
Maximum solid load	6 Kg / 2 Kg	6 Kg / 2 Kg	

S and N Cycles**

Password-activated

	S 134	S 121	
Description	Sterilization of bagged or non-bagged solid products	Sterilization of bagged or non-bagged solid products and of plastic products	
Temperature	134°C	121°C	
Pressure	2.05 bar	1.05 bar	
Sterilization phase duration	4'	20'	
Drying phase duration	15'	15'	
Total duration with standard load*	18'	32'	
Maximum solid load	6 Kg	6 Kg	

	B 134 prion	B 134 - fast	B 134 prion - fast
	Prion cycle for solid, porous or hollow, bagged and non-bagged material	Fast cycle for solid, porous or hollow material, bagged and non-bagged (1 tray)	Fast prion cycle for solid, porous or hollow material, bagged and non-bagged (1 tray)
	134°C	134°C	134°C
	2.05 bar	2.05 bar	2.05 bar
	18'	3'5"	18'
	15'	4'	4'
	43'	27'	42'
	6 Kg / 2 Kg	0.6 Kg / 0.2 Kg	0.6 Kg / 0.2 Kg

	N 134	N 121
	Sterilization of non-bagged solid products	Sterilization of non-bagged solid products and of plastic products
	134°C	121°C
	2.05 bar	1.05 bar
	4'	20'
	4'	4'
	24'	33'
	6 Kg	6 Kg

** Times are exclusive of the drying phase. The time may vary by +-5%.*

*** All cycles are available unless specific national legal regulations state otherwise.*

Load capacity

The maximum load for the 24-litre E9 is 6 Kg for bagged solid materials.

E9 offers 4 solutions to optimise the load to be sterilized according to different needs: the standard tray holder including 5 trays supplied with the autoclave and 3 optional tray holders.

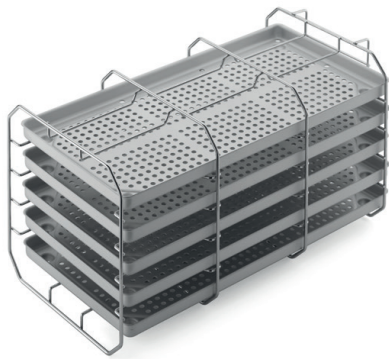

Standard tray holder

The square panelled stainless steel tray holder is designed for loading 5 standard aluminium trays. When rotated by 90°, it allows 3 rows of bagged cassettes to be inserted. 5 trays included.



Dimensions

Tray holder: 19.5 x 19.5 x 40 cm (wxhxd)
Tray: 18.5 x 2 x 38 cm (wxhxd)

Suggested configurations

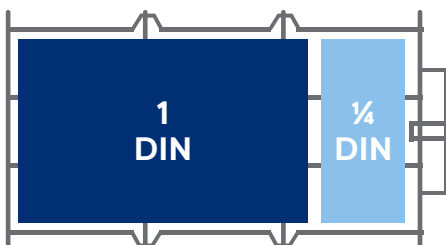

1 x 1 DIN cassette + 1 x 1/4 DIN cassette x 3 compartments

Total cassettes: 3 x 1 DIN + 3 x 1/4 DIN
Total DIN: 3 DIN and 3/4
Load to be sterilized*: 3.5 kg

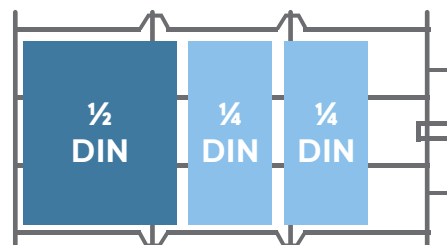

1 x 1/2 DIN cassette + 2 x 1/4 DIN cassette x 3 compartments

Total cassettes: 3 x 1/2 DIN + 6 x 1/4 DIN
Total DIN: 3 DIN
Load to be sterilized*: 3.5 kg

* Recommended and variable load depending on the type and weight of the cassettes used.

Optional accessories



Tray holder for cassettes

Convex steel tray holder allows the insertion of 5 standard aluminium trays or, when rotated 90°, 4 x 1 DIN and 4 x ¼ DIN bagged cassettes. Trays not included.



Dimensions

19.5 x 22.5 x 40 cm (wxhxd)

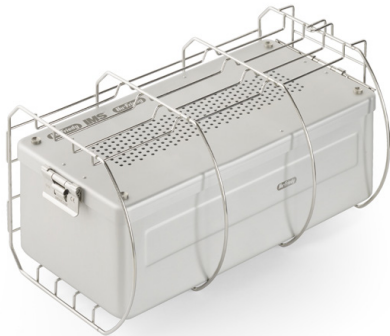

Tray holder for sterilization unit

Rounded steel tray holder, allows the insertion of 5 standard aluminium trays or, if rotated by 90°, one or more sterilization containers. Trays not included.



Dimensions

19 x 15 x 38 cm (wxhxd)

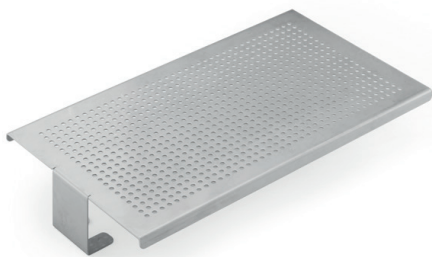

Universal support surface

Steel support surface suitable for larger loads. To be installed directly in the boiler, after removal of the supplied tray holder.



Dimensions

19.5 x 5.5 x 35 cm (wxhxd)

Complete and expandable traceability

With E9, the management and archiving of the results of the sterilization process is simplified by means of a digital and paper-based traceability system. All sterilization cycles are saved on the SD Card (standard) and can be transferred to a PC via Ethernet connection (standard) or WiFi (optional). The 3 different types of printers (optional) allow cycles to be printed on thermal paper or labels.



Print Set 1

Internal printer with thermal paper, for accessing paper-based cycle recording, for keeping records.



Print Set 2

Internal printer for adhesive labels, for labelling loads securely with the possibility of printing barcodes as well.



Print Set 3

External printer for adhesive labels, for printing large quantities of adhesive labels, including barcodes.

E9

Euronda | Pro System



Digital traceability

Compliant with EN 13060, storage is available either on an SD Card for the easy transfer of all data from the autoclave to the computer, or via the standard Ethernet connection or optional WiFi.



Load validation and release

This function allows the user to digitally record the conformity of the sterilization process, both during loading and unloading. Once the operator has checked the integrity and drying of the pouches, the status of the instruments and compliance with the sterilization parameters, the load can then be validated.



Print sets options

The expandable traceability system allows 3 different types of printers to be installed, depending on requirements. Print Set 1 and 2 are installed at the front of the autoclave without additional space, while Print Set 3 is placed outside the device.



E-Memory

For total traceability in your practice

E-Memory is the software for the complete archiving, management and traceability of all sterilization cycles and data directly on a PC. This application can automatically, semi-automatically or manually capture data from the sterilization process and save it directly to the computer. This data can be easily organised, searched, printed and emailed.

E-Memory also makes it possible to trace and select all information related to the cycles performed by the different devices (thermodisinfector, sealer and autoclave) involved in the sterilization process.

It is easy to consult and manage, and allows you to send selected cycles and data directly to technical support in just a few clicks, and to automatically produce reports and PDF certificates with header, graphic logo and personal data.



Download



Control test

The Euronda Pro System product range includes 3 function tests, designed as a perfect complement to the daily use of the autoclaves. The purpose of these tests is to verify the operational effectiveness of the autoclave in performing type B or S cycles.



Helix test

Control test for Class B autoclaves to assess the steam penetration capacity in hollow loads.



Packaging

Pack with 1 cannula and 250 control indicators

Bowie & Dick test

Control test for autoclaves to check steam penetration capacity in porous loads.



Packaging

Pack of 10 tests

Prion test

Test for class B autoclaves. Calibrated to temperature, time and pressure parameters considered effective in 134° Prion cycle sterilization (134° x 18 minutes).



Packaging

Pack of 200 control indicators

Water treatment systems

The water used to feed the autoclaves within the practice must be treated to ensure proper functioning and prolong the life of the devices.

Euronda Pro System offers a range of water treatment devices to choose from depending on the conductivity value of the water and the number of autoclaves in the practice.

Device	Water conductivity	Number of autoclaves
Aquaosmo*	$\leq 800 \mu\text{S}$	1 to 4 autoclaves
Aquafilter 1 to 1	$\leq 600 \mu\text{S}$	1 autoclave
Aquadist	Any level of conductivity	Any number of autoclaves

**Aquaosmo is equipped as standard with an Aquabox device for connecting the autoclave to the water treatment system. An Aquabox device must be set up for each additional autoclave.*

Aquaosmo

The advanced osmosis system for multiple autoclaves



Device for the production of osmosis water through a reverse osmosis process, suitable for clinics with high water hardness. The filtering system consisting of a sediment filter and carbon filter, resin and osmotic membrane, guarantees high quality water production, suitable for supplying the autoclaves and all the practice's equipment in compliance with standard EN 13060 (<math><15 \mu\text{s}/\text{cm}</math>). Designed to be connected directly to the autoclave after installation of the Aquabox device, Aquaosmo can supply from 2 to 4 autoclaves at the same time if fitted with a 12-litre capacity external storage tank kit (both accessories are included). Aquaosmo does not require a power supply and can be installed on a worktop or inside a cabinet. Aquaosmo offers excellent filtration performance and reliability with reduced environmental impact, thanks to the use of a single resin with a guaranteed life of 12 months.



Dimensions

30 x 35 x 16 cm (wxhxd)



Weight

5.3 kg (empty)



It can supply

Up to 4 autoclaves



Water production

1 L of water every 20 minutes



Supply pressure

min 2 / max 8 bars



Inlet water conductivity

Max. 800 μs



Speed

Thanks to the filter system, it can deionise 1 litre of water in 20 minutes.



Compatibility

Aquaosmo connects directly to all class B autoclaves thanks to the Aquabox device.



Multiple autoclaves

It can supply up to 4 autoclaves at the same time thanks to the 12-litre storage tank.



Practical

It does not require a power supply and can be installed on a worktop or inside a cabinet.

Aquafilter 1 to 1

The ideal deionisation system for a single autoclave



Device for the production of deionised water for autoclaves, in accordance with EN 13060 (< 15 $\mu\text{S}/\text{cm}$). Only one Euronda Pro System autoclave can be supplied. It deionises on average 1 litre of water per minute. It can be equipped with automatic shut-off device. It can be placed directly on the worktop or inside a cabinet, as well as mounted to a wall. Included in the initial equipment are two ion exchange resins.



Dimensions

39 x 45.5 x 14.5 cm (wxhxd)



Weight

8.4 kg (empty)



It can supply

1 autoclave



Water production

1 L of water every minute



High-performance

It allows quick, easy and effective autoclave feeding.



Easy to install

The quick couplings allow direct connection to the power and water supply.



User-friendly

An indicator light shows the conductivity level of the water, indicating when the resins need to be replaced.



Resilient

It also withstands high inlet pressures (up to 10 bar).

Aquadist

Distilled water ready for every need



Water distiller for obtaining distilled water by boiling and subsequent steam condensation. It distils 0.7 L of water per hour. 4-litre capacity. It fulfils the safety and electromagnetic compatibility (2014/30/EU) and low voltage (2014/35/EU) tests.



Dimensions
23 x 36 cm (Øxh)



Weight
3.5 kg



Water production
0.7 L of water every hour



Power consumption
580 W



Practical

Easy to use, it produces ready-to-use distilled water in no time.



Effective

Its 4-litre capacity makes it useful for covering several sterilization cycles.

Technical features

Overall dimensions	46 x 43.5 x 61 cm (wxhxd)
Minimum depth of the support surface	50 cm
Minimum width of the support surface	46 cm
Minimum space above the tank	30 cm
Weight (empty machine with tray holder and tray)	47.5 Kg
Weight per support area (full tank and chamber with maximum load)	48 Kg + 9 Kg = 57 Kg Load on each foot: 14.3 Kg
Power supply	230 V 50/60 Hz
Absorption	2300 W 10 A
Average water consumption per cycle	0.3 L
Tank capacity (clean water/used water)	4 / 4 litres
Noise	50 dB
Accessories included	Standard tray holder and 5 trays, drainage pipes, sponge, tray extraction handle, door adjustment handle, funnel

Compliance with harmonised standards

- EN 13060
- EN 14971
- EN 61010-1
- EN 61010-2-040
- EN 61326
- EN 13445

Documentation

- User's manual
- Declaration of room conformity
- Declaration of autoclave conformity
- Warranty certificate
- Installation sheet
- Service booklet

Certifications

- Medical Device Class IIb compliant with Regulation (EU) 2017/745 (MDR)
- Chamber compliant with Directive 2014/68/EU
- Certified company: ISO 9001, ISO 13485, ISO 14001
- Model: SSU\M24L2023

Technical data sheet

Dimensions and footprint (cm)

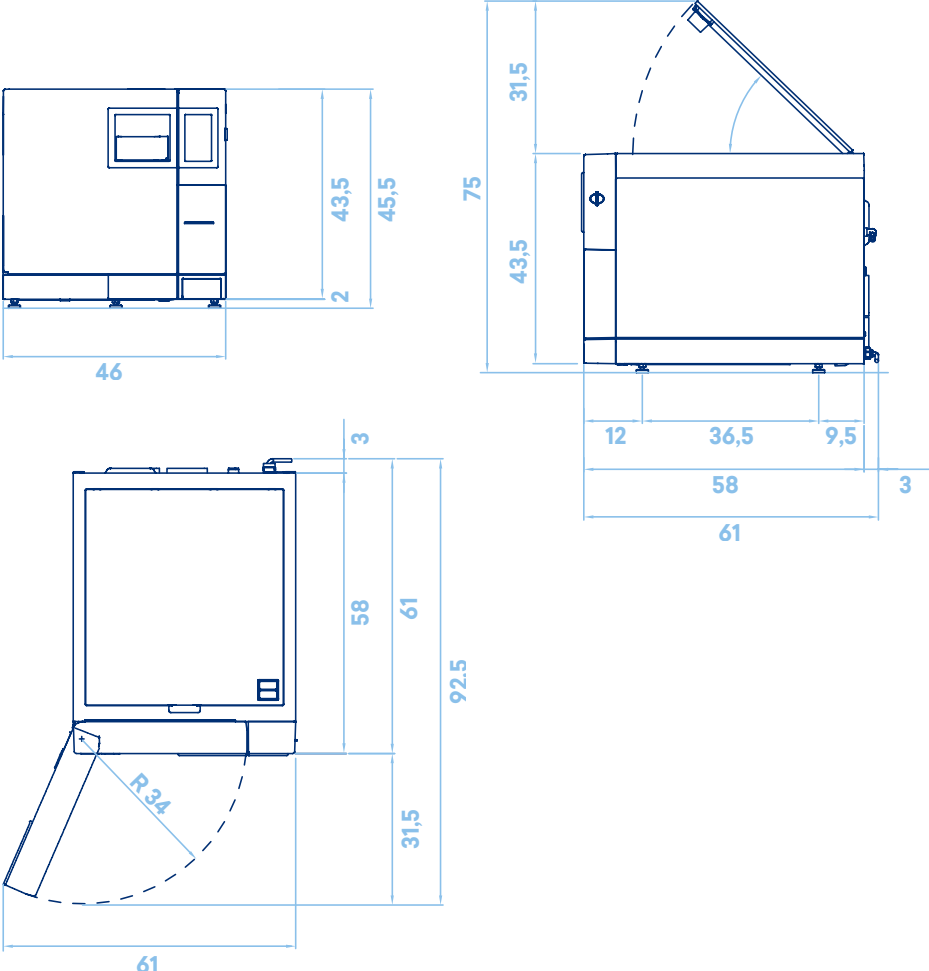

Chamber size (cm)

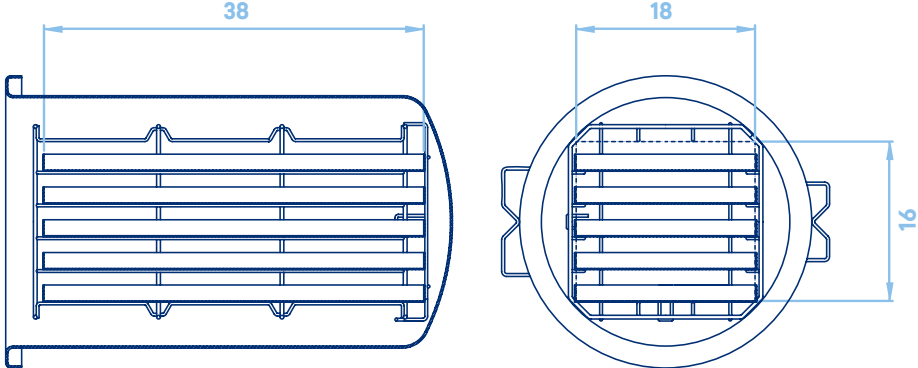

Euronda Spa® 2023

This catalogue may not be copied, reproduced or scanned by any means. All rights reserved.

Images, descriptions, technical specifications and features are purely indicative.

While maintaining the basic features of the product, the manufacturer reserves the right to make changes at any time with the sole aim of improvement.

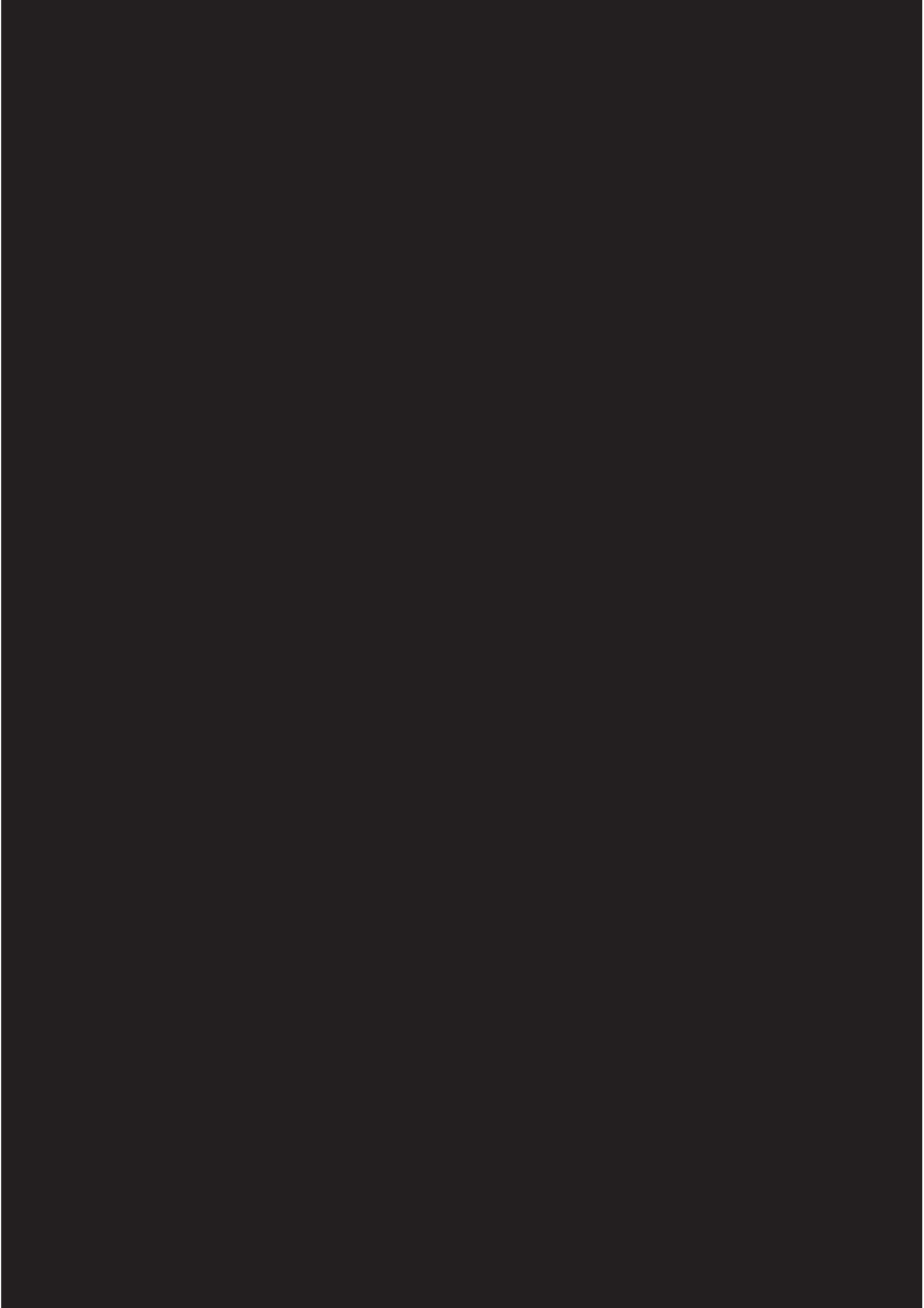

Euronda Spa

Via Chizzalunga 1
36066 Sandrigo
Vicenza, Italy
t +39 0444 656111
f +39 0444 656199
m info@euronda.com
www.euronda.it

Deutschland

Euronda Deutschland
Am Landwehrbach 5
48341 Altenberge, Deutschland
t +49 2505 9389 0
f +49 2505 9389 29
m info@euronda.de
www.euronda.de

France

Euronda France Eurl
ZAC les Vallées, Avenue de Bruxelles
60110 Amblainville, France
t + 33 (0) 3 44 06 69 70
m info@euronda.fr
www.euronda.fr

España

Identyd
Calle Músico Antonio Rodríguez
de Hita, 12 Bajo 30007 Murcia
España
t 900102034
m info@euronda.es
www.euronda.es

Russia

OOO Euronda Russia
193149 Leningradsakaya obl.,
Vsevolozhsky r-on,
d. Novosaratovka, ul.
Pokrovskaya, dom 41, litera B.
Russia
t + 7 (812) 635 88 94
m info@eurondarussia.com
www.eurondarussia.com

Euronda[®]